

TOWER BRACKET ASSEMBLY

NO.	DESCRIPTION	QTY.
1	FINE AZIMUTH BRACKET	1
2	FINE ELEVATION BRACKET	1
3	PIPE BRACKET A	1
4	PIPE BRACKET B	1
5	M10x150 HEX BOLT	2
6	M10 NUT	2
7	M10 LOCK WASHER	2
8	M10 FLAT WASHER	2
9	M8x35 HEX BOLT	3
10	M8 LOCK WASHER	3
11	M8 FLAT WASHER	3
12	M10x45 HEX BOLT	3
13	M10 LOCK WASHER	3
14	M10 FLAT WASHER	3

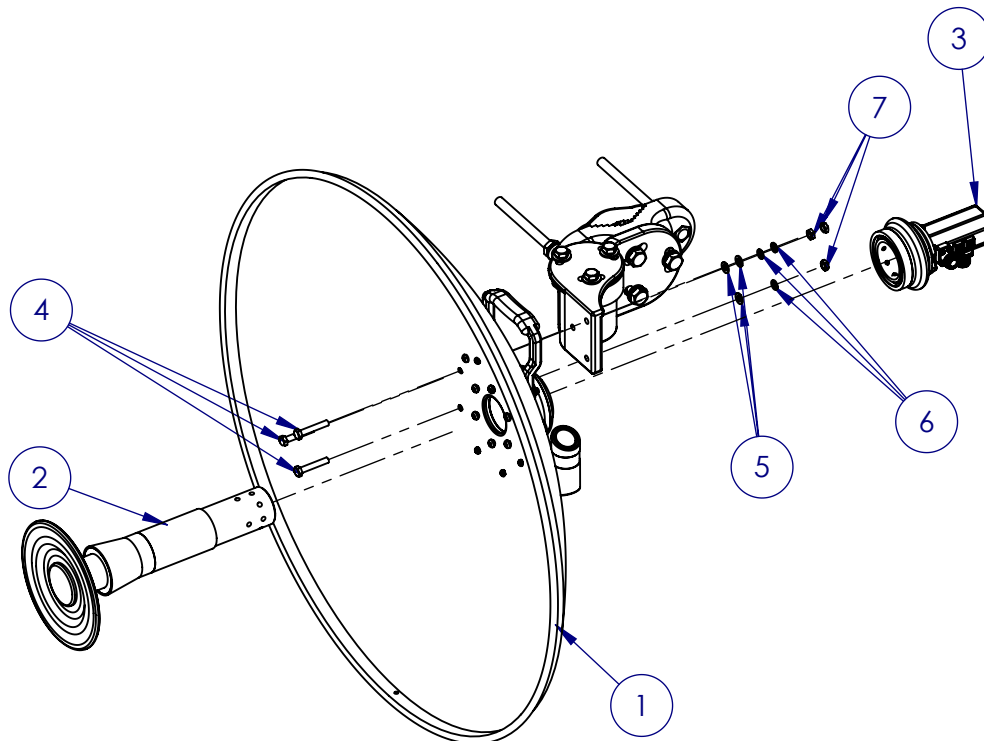

TOOLS REQUIRED: 13MM WRENCH/SOCKET
17MM WRENCH/SOCKET

RECOMMENDED
TORQUE SPECIFICATIONS

⑥ ⑨ ⑫ - 25 Nm

Go to
www.kpperformance.com
for more detailed
installation instructions.

NO.	DESCRIPTION	QTY.
1	2' Parabolic Dish	1
2	WAVEGUIDE FEED	1
3	N-TYPE WAVEGUIDE LAUNCHER	1
4	M5X40 PHILLIPS PAN HEAD	3
5	M5 FLAT WASHER	3
6	M5 LOCK WASHER	3
7	M5 NUT	3
8	PIPE BRACKET ASSEMBLY	1